



KÖBO

The Chain People

Hand in hand with the **BULK HANDLING INDUSTRY**



MEETING REQUIREMENTS

EXCEEDING EXPECTATIONS

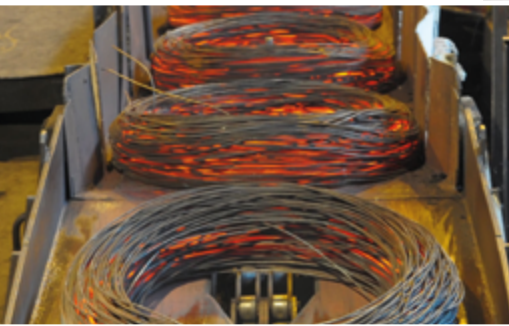

WE ARE A COMPETENT PARTNER TO THE BULK HANDLING INDUSTRY.

KOBO chains are famous for their specific quality. They are used in various applications.

In the cement industry:
clinker • clinker dust • gypsum • marl • clay
cement • limestone

In the mining industry:
coal • ore • crushed rock • limestone • slate

In the energy industry:
biomass • coal • bed ash

In the paper industry:
wood • wood chips

In automotive and metal processing industries:
scrap metal and punching waste

Further industries where KOBO products are used:
transportation of granulate in the fertilizer industry
and of many materials in the plastic molding industry

The requirements of the bulk handling industry are very particular. For decades KOBO has worked with international OEMs to develop special solutions for various applications. For the transportation of coarse or fine grained material as well as loose material with corrosive or abrasive characteristics.

We develop optimized chains and sprockets as well as a broad range of attachments.

INDUSTRY SPECIFIC SOLUTIONS FROM KOBO.

We develop and manufacture:

reclaimer chains

bucket elevator chains and buckets

pan conveyor chains, rollers and pans

as well as sprockets and traction wheels for almost all applications in the bulk handling industry



WE MOVE YOUR BUSINESS



Since 1894 KÖBO has been the name for top-class chain technology. Our high quality standards, constant innovation, state-of-the-art manufacturing, and attention to product safety have made KÖBO a leading supplier of chains and sprockets. Today KÖBO specialists work around the globe to provide effective and innovative solutions:

We are: "The Chain People".

A COLLABORATION THAT WORKS.

Strategic thinking, pragmatic acting, and a distinctive understanding of the requirements in the industry have created our brand. Our chains are well known for their extended lifetime, optimized bearing pressure characteristics, and low friction coefficients - resulting in maximum productivity.



KÖBO Industrial Park Germany

BEST IN CLASS SOLUTIONS AND FIRST CLASS SERVICE.

KÖBO is acting globally. With know-how, experience, top-quality customer service, we create competitive advantages for our customers. Every project is a new challenge. We work hand in hand with our customers to make out the specific requirements and to provide the best solutions for each project. Besides chains and sprockets, KÖBO manufactures attachments, special rollers, buckets as well as pans and single components for specific drive and conveyor solutions.

How can we support you?

RECLAIMER CHAINS AND ROLLERS

CONVEYING - STATE OF THE ART

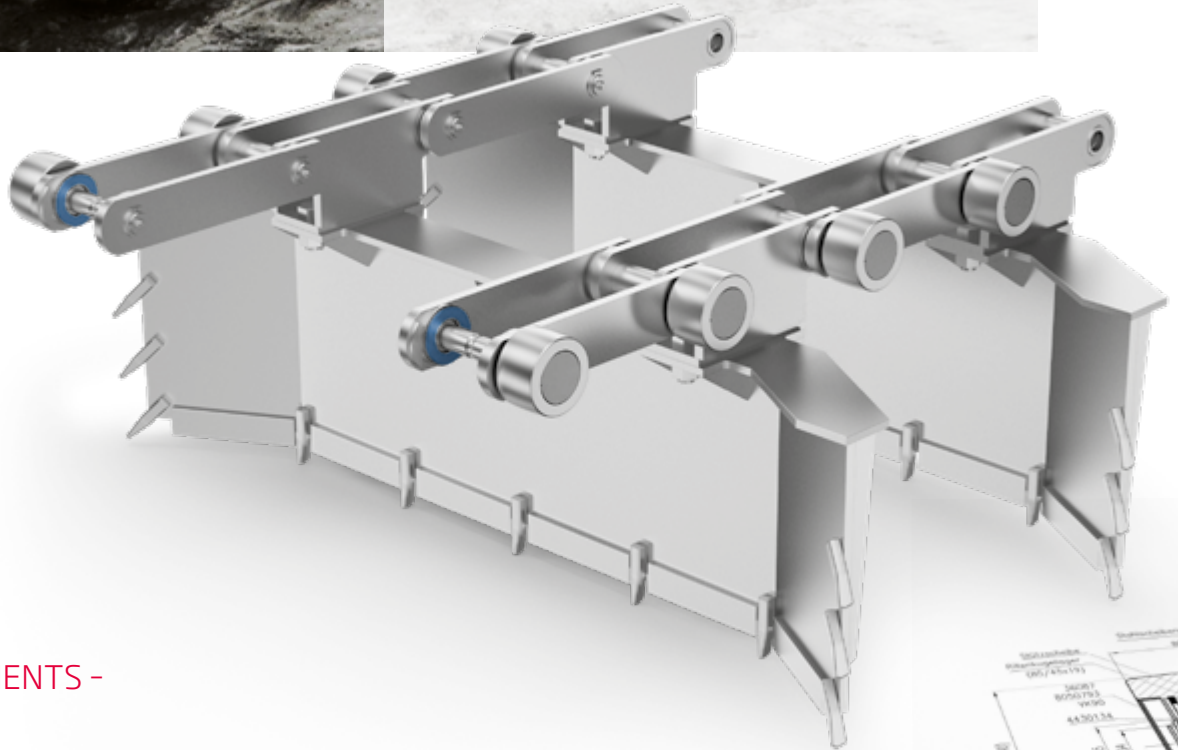

Double-strand reclaimer chain with outside roller

TOUGHEST REQUIREMENTS - HIGHEST DURABILITY.

KOBO designs and manufactures standard and custom-made reclaimer chains for the bulk handling industry. Chains with bent or welded attachment, with inner or outer roller, in lubed or maintenance-free execution - KOBO consults with the customer for the optimal chain design. We provide 120 years of chain experience.

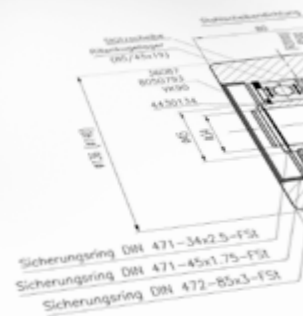



DURABLE PERFORMANCE.

Almost all chain designs can also be manufactured in maintenance-free execution on request.

The advantage is that the seal keeps a stable grease paste in the chain link, which extends the service life considerably. In addition, KÖBO is able to offer a wide variety of material combinations and coatings for our customers and thus to minimize wear and to extend the chain life.

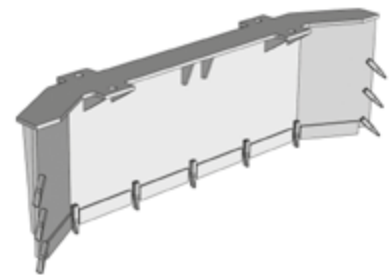

SCRAPER with bolt-on teeth and welded stiffening ribs

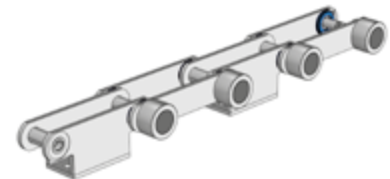

RECLAIMER CHAIN with outside mounted roller and protection roller inside

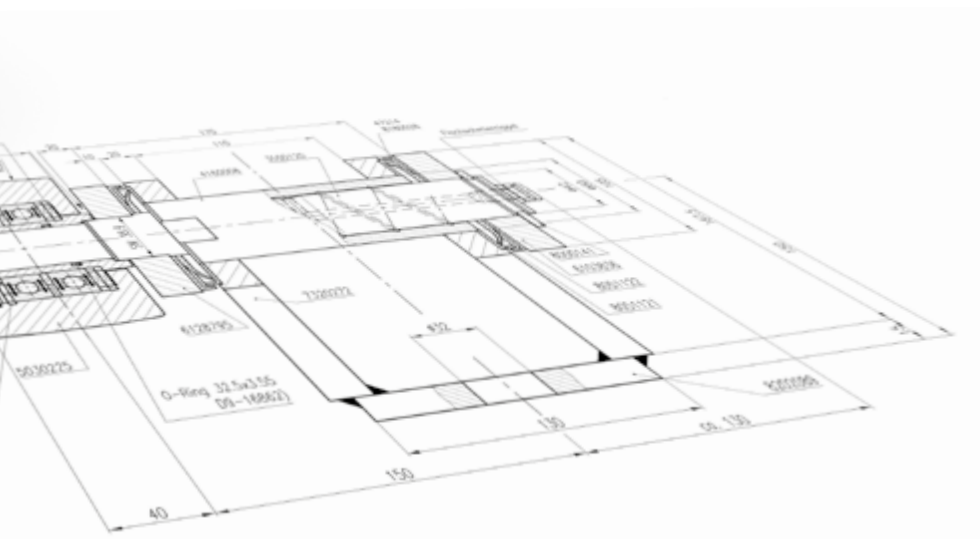

SEALED ROLLER with bearings in maintenance-free execution

BUCKET ELEVATORS

MOVING ON UP - WITH HIGHEST QUALITY



INCREASING PRODUCTION. RAISING OUTPUT.

Bucket elevators are used for vertical transportation of bulk material. Abrasive, coarse or hot materials require the highest wear resistance in the chains. Therefore bucket elevators are designed with a center or a double-strand chain system.

KOBO's bucket elevator chains meet the highest standards in wear resistance and fatigue strength. Chains are designed and manufactured with welded, bent or forged attachments.



Double-strand bucket elevator chain assembly with bucket

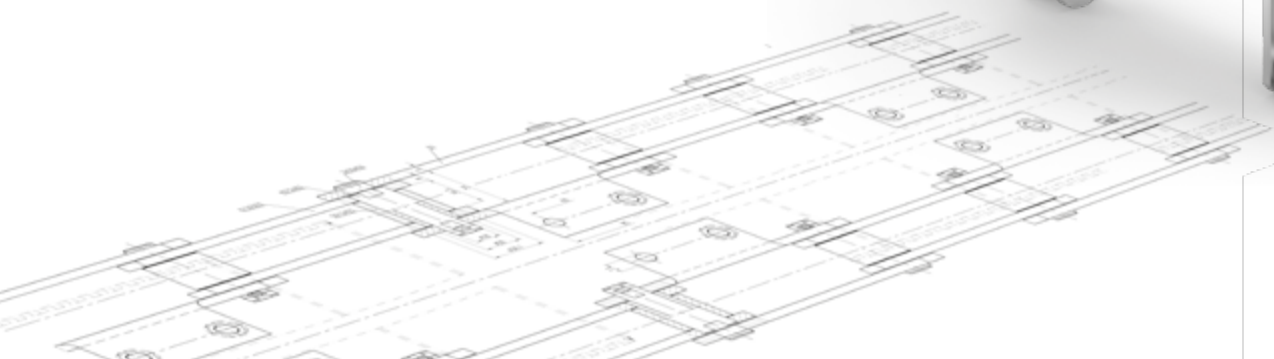

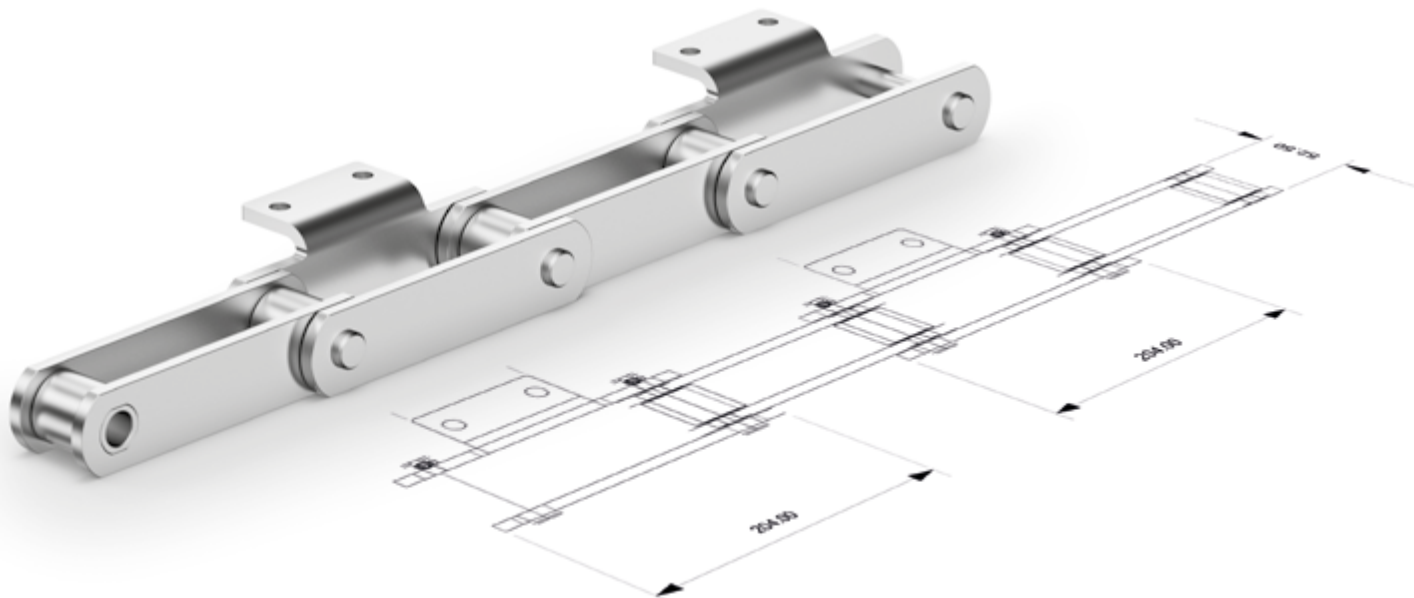

Areas of operation:

cement mills

asphalt mixing plants

limestone quarries

steel plants

and many more

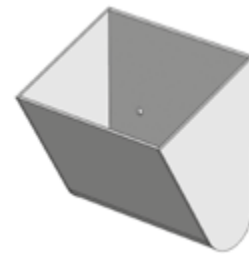

BUCKET ELEVATOR

We supply various types of buckets - custom-made for your individual approach

AIMING HIGH - AND HIGHLY INDIVIDUAL.

KOBO's high performance bucket elevator chains are custom-made and designed according to the specific working environment. The interaction between chain and bucket is important for the lifetime of the system. Therefore KOBO manufactures the buckets as well. Special designs and custom-made products are developed between the customer and KOBO's engineering team.

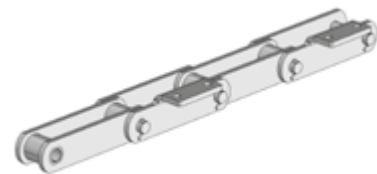

BUCKET ELEVATOR CHAIN with protection roller, head pin, and attachments on every outer link

PAN CONVEYORS

EXTREMELY RELIABLE



COPING WELL WITH HIGH STRESS SITUATIONS.

The requirements on pan conveyor cells are extremely high. In general, they are exposed to high shock loads and high forces. The special KOBO quality provides a competitive advantage. Most of our pans consist of three units that are optimally adapted by our experts to your needs.

chain with one- or double-bent attachment,
single or double strand

steel

rollers mounted on pan



EVEN UNDER HARDEST CONDITIONS

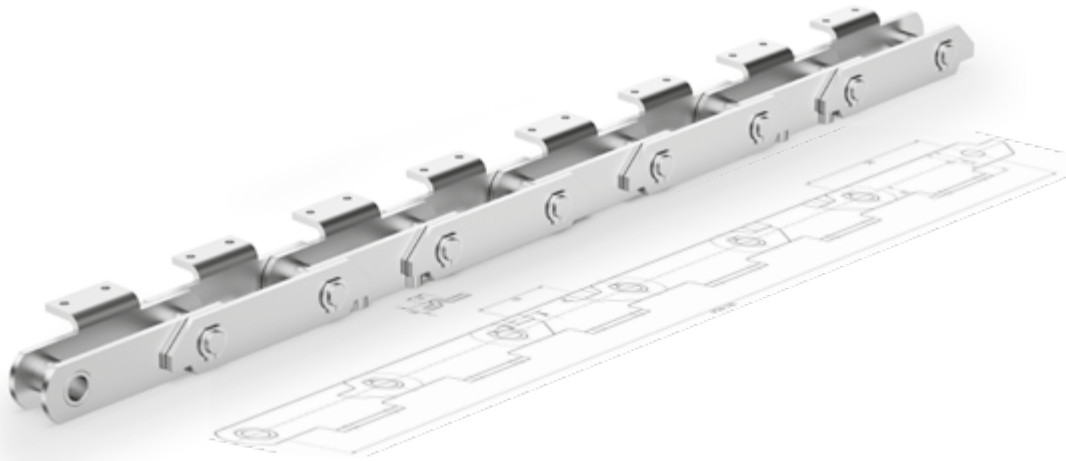

DETAILS THAT CREATE VALUE.

The correct choice of materials contributes to high load capacity and long service life. The chain pitches usually are 160, 250 or 315mm. The chains can be made in non-back-bending execution.

Using outboard rollers on the pans, the material can be transported safely and reliably. Our roller options, can be realized as normal or flanged rollers.

Typical areas of application for pan conveyors are:

silos feeding

hot material

cement clinker

limestone

dirt and gravel

coke

slag

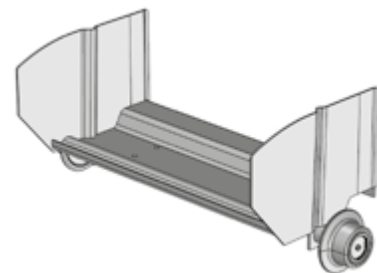

STEEL PAN in roller carrying execution



CHAIN in non-back bending execution

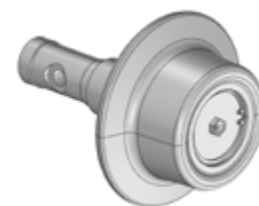

FLANGED ROLLER with bearings in maintenance-free execution

SPROCKETS

SETTING YOUR BUSINESS IN MOTION

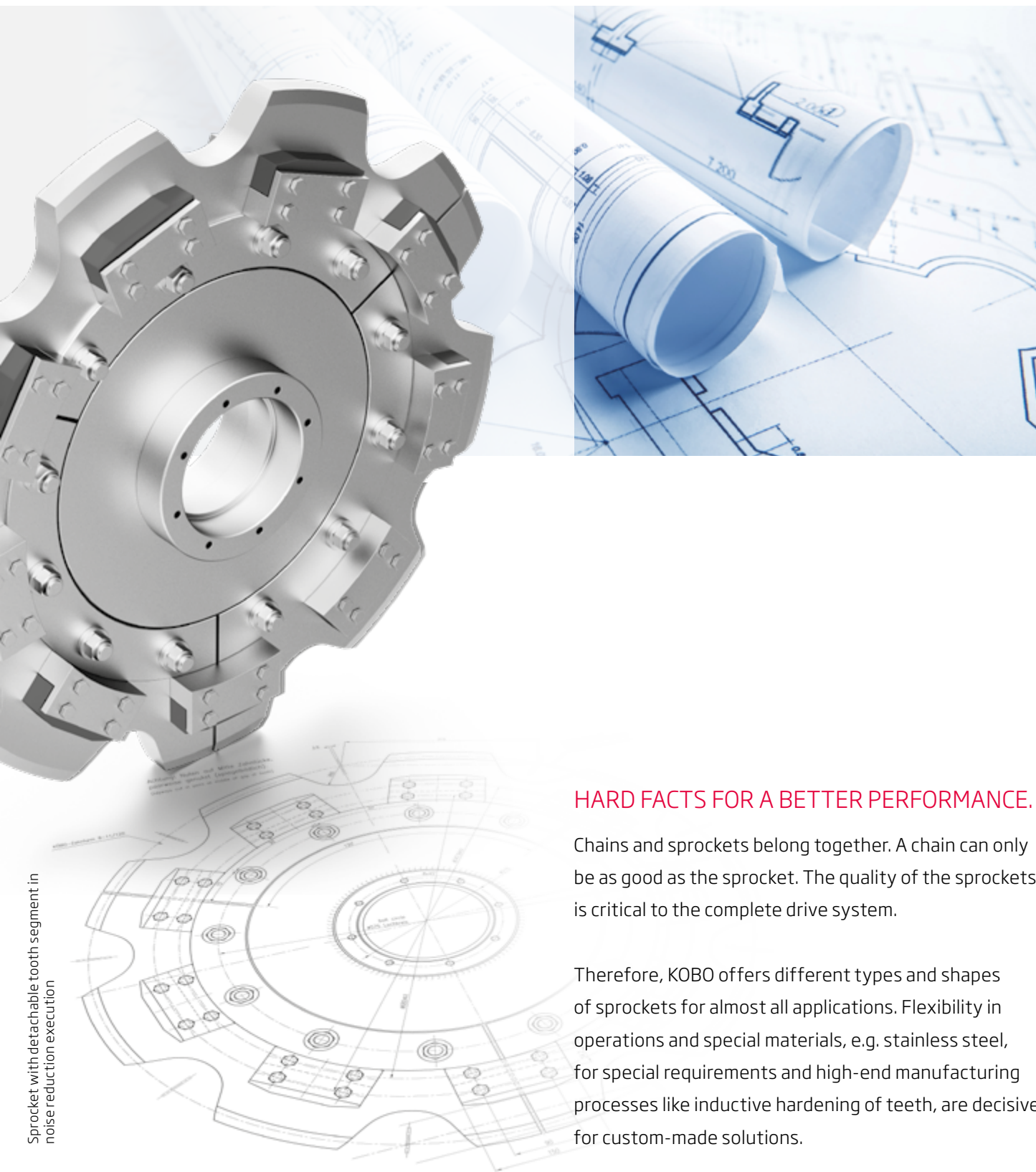

HARD FACTS FOR A BETTER PERFORMANCE.

Chains and sprockets belong together. A chain can only be as good as the sprocket. The quality of the sprockets is critical to the complete drive system.

Therefore, KOB0 offers different types and shapes of sprockets for almost all applications. Flexibility in operations and special materials, e.g. stainless steel, for special requirements and high-end manufacturing processes like inductive hardening of teeth, are decisive for custom-made solutions.

Sprocket with detachable tooth segment in noise reduction execution



KÖBO

The Chain People

AND IT MOVES ON

Drive sprocket



Split sprocket



KOBO'S sprocket features:

sprockets with hub on one side or both sides

sprockets with welded on hub

sprockets with keyway

sprockets with thread holes for adjusting screws

sprockets with grooves for dirt-releasing notches

sprockets with increased tooth gap clearance

sprockets with segmental rims

sprockets with induction hardened teeth

SIMPLY MAKING MORE POSSIBLE.

KOBO manufactures single, duplex or triplex sprockets up to a diameter of 5.5ft.

Standard sprockets, custom-designed sprockets for engineered chains as well as sprockets for roller chains are part of our portfolio.



Our customers can rely on us:

KOBO is certified acc to DIN EN ISO 9001:2015

KOBO HEADQUARTERS

KÖBO GmbH & Co. KG
Hatzfelder Str. 115
D-42281 Wuppertal
Germany
Tel.: +49 202 7093-0
Fax: +49 202 7093-142
E-Mail: info@koebo.com
www.koebo.com

ASIA

The Chain House / KÖBO Asia
162/2 Phattanakarn Rd. 78
Prawet Parwet 10250 Bangkok
Thailand
Tel.: +66 2321 6913 5
Fax: +66 2321 6916



USA

KOBO USA LLC
370 Great SW Pkwy SW
Suite H, Atlanta, GA 30336
Tel.: +1 630 464 8447
E-Mail: info@kobousa.com
www.kobousa.com

**BRANCH OFFICE CHICAGO /
BRANCH OFFICE MIAMI**

SOUTH AFRICA

Greenstone Hill, Johannesburg
South Africa
Tél. : +27 (0) 836501639
naigel.pera@gmail.com
n.pera@koebo.com
www.koebo.co.za

POLAND OFFICE

Köhler & Bovenkamp Polska
Polska Sp. z o.o.
88-400 Znin ul. Przemysłowa 2
woj. kujawsko-pomorskie
Tel.: +48 52 30 31 36 1
Fax: +48 52 30 31 36 4
E-Mail: marketing@koebo.pl
www.koebo.pl

UK OFFICE

KÖBO (UK) Ltd. Ketten House
Leestone Road,
Sharston Industrial Area,
GB-Manchester, M22 4RB
Tel.: +44 (0)161 491 9840
Fax: +44 (0)161 428 1999
E-Mail: info@kobo.co.uk
www.kobo.co.uk

FRANCE OFFICE

KÖBO France S.A.R.L.
6 rue du Chant des Oiseaux
F-78360 Montesson
Tel.: +33 1 30 15 24 50
Fax: +33 1 34 80 16 50
E-Mail: kobo.france@wanadoo.fr
www.koebo.com/fr



MEETING REQUIREMENTS.
→ EXCEEDING EXPECTATIONS.